

Mounted stubble cultivator
SYNKRO

 **PÖTTINGER**

Perfect incorporation



Cultivating the soil



The classic implement for conservation in soil preparation is the stubble cultivator. The incorporation of harvest residues near the surface increases the fertility of the soil and promotes rotting and humus formation. SYNKRO stubble cultivators in two or three-row versions with a choice of rear rollers, create the ideal conditions for the germination of weeds, volunteers and cover crops.

Table of contents

For perfect incorporation	4-5
Mounted stubble cultivators	6-9
Flexible mounting options	6-7
Proven share geometry	8-9
Two row mounted cultivators	10-15
Two row mounted cultivators	10-13
Two row mounted cultivators – folding	14-15
Three row mounted cultivators	16-27
Three row mounted cultivators - rigid / folding	16-23
Cover crop sowing unit – TEGOSEM	24-27
Accessories / Technical data	29-39
Rear rollers	29-31
Equipment options	32-33
Accessories	34-35
Technical data	36-37
MyPÖTTINGER / ORIGINAL PARTS	38-39



All information on technical data, dimensions, weights, output, etc. and the images shown, are approximate and are not binding.

The machines shown do not feature country-specific equipment and may include equipment that is not supplied as standard, or is not available in all regions. Your PÖTTINGER dealership would be pleased to provide you with more information.

Perfect incorporation

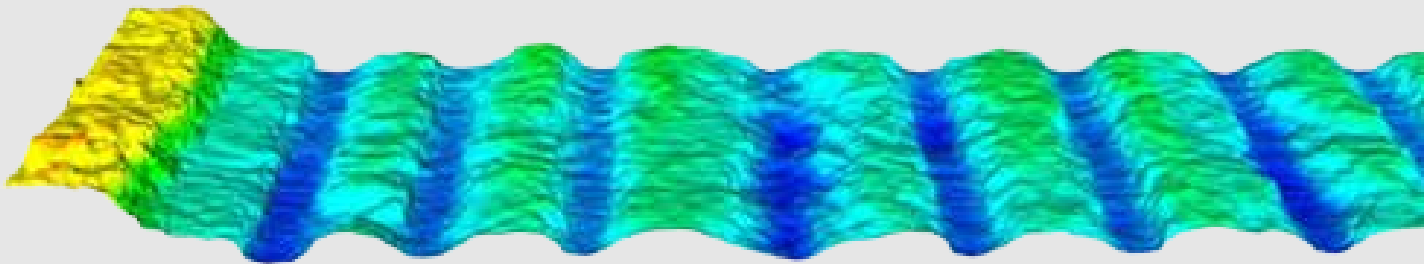
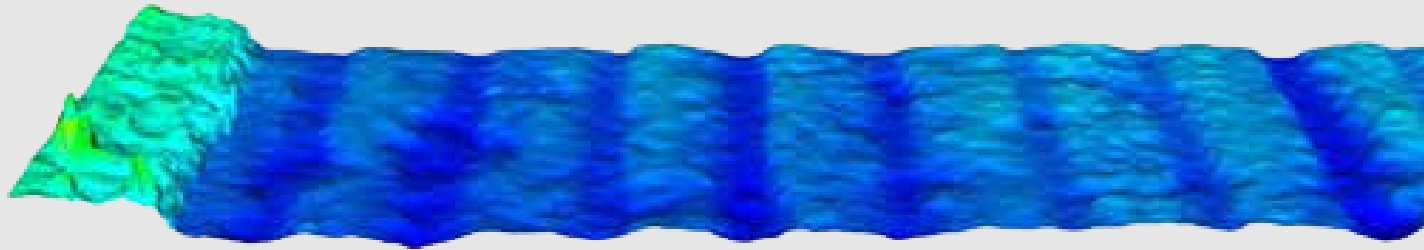

Ultimate cultivation

Moving the whole surface, perfect incorporation and excellent quality tilth are what make SYNKRO stubble cultivators so popular with users. All our stubble cultivators are equipped with the fieldproven share geometries. These ensure uniform incorporation and intensive mixing of harvest residues, slurry, muck, mulch, etc. even in tough operating conditions. The mixing of residue from the harvest increases the fertility of the soil and protects from erosion.

Creating the best conditions

Because the wing shares overlap, the whole area of soil is cultivated thoroughly with both the deep and very shallow settings. For a working depth between 5 and 30 cm.

For shallow and deep cultivation

The points and wings ensure thorough mixing of the soil. Regardless of whether you intend to work very shallow or deep. Being able to adjust the height and angle of the wings ensures optimum soil penetration and mixing performance.

Unique working results are achieved with the shallow setting thanks to the low penetration depth. Only PÖTTINGER stubble cultivators manage to produce such a perfectly level result. **1**

This ensures an ideal soil climate and reduces cavities in which moisture can collect. These areas often serve as breeding ground for pests and diseases.

As a result of the flat ridge formation, optimum consolidation is guaranteed by the rear roller.

Figure 2 shows the ridges formed by other cultivators on the market. Due to the deep corrugations, volunteer seeds and weeds accumulate unevenly. **2**

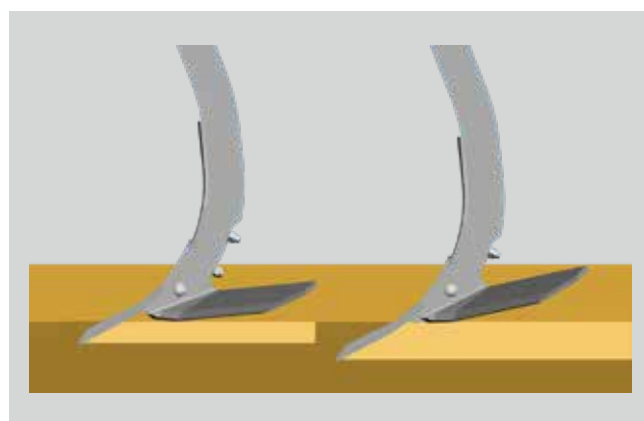
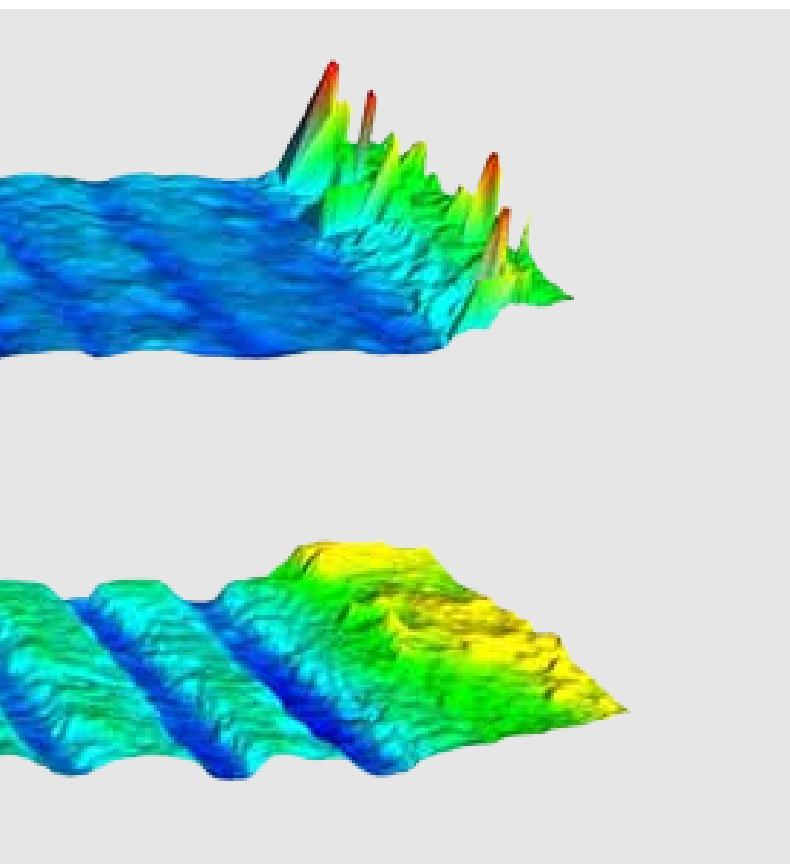

The right position for all operating conditions

Together with the shins, the curved legs ensure optimum soil flow.

The tines are fitted with shear bolts as standard. A hole matrix on the leg mounting plates and the position of the cultivator wings can be used to respond to different operating conditions such as dry, hard soils.

- SYNKRO Standard: Three positions
- SYNKRO NOVA: Two positions

Shallow cultivation with PÖTTINGER

Being able to adjust the angle of the wings enables shallow cultivation with the point positioned only approx. 1 cm below the working level of the wings.

Wings set low and flat - less aggressive point

- Shallow cultivation
- Uniform level surface
- Ideal for stubble cultivation and weed control.

Wings set high and steep - more aggressive point

- Deep cultivation
- Reliable soil penetration
- Increased mixing effect
- Ideal for incorporating fertiliser and organic matter.

Flexible settings



Ingenious setting system

Using a straightforward pin-in-hole system, the working depth can be quickly adjusted using the rear rollers.

- Only one adjustment point at the front even on folding cultivators.
- The position of the rear roller is locked to provide additional transfer of weight from the rear roller to the stubble cultivator.

Maintenance-free levelling discs

The levelling discs are scalloped. They are guided by the rear roller and adjusted together in parallel to change the working depth; they can also be independently depth adjusted in pairs. A six-lip labyrinth seal provides completely tight protection for the bearings. As a result the bearing is completely maintenance-free.



Edging boards

The optional edging boards are mounted right next to the outer tines to deflect soil back under the rear roller and prevent ridges forming.

The height and angle of the edging boards can be adjusted.

The edging boards are able to deviate to the rear. Pre-tensioned springs on the sides ensure that edging boards can deviate to the side. These can be folded inwards on rigidframe SYNKRO cultivators to reduce transport width.



Hydraulic depth adjustment as an option

- Infinitely variable response to different soil conditions
- Clearly visible working depth indicator
- Available as an option on all rigid and folding models
- Convenient adjustment without leaving the tractor cab

Proven point and wing share geometry



1 CLASSIC points and wings

- Good soil penetration especially on very hard soils
- The shallow alignment of the point enables minimal difference in angle compared to the wings, which remains the same even if the point is worn
- A working depth of 5 cm to 30 cm is achievable
- Consistent tillage performance
- Tines are mounted with two bolts
- Thanks to the double mounting there is no risk of losing the point even in really tough soil conditions
- 15 mm material thickness at share point
- Increased material thickness in the area subject to most wear



2 DURASTAR cultivator points

- 4 times the durability compared to standard points
- High quality coating on the front side of the point
- High tungsten-carbide content for longer service life
- Resistant to wear even in stony conditions
- Special point shape with higher volume in the area subject to most wear
- High quality steel that retains the shape of the tool
- Coating even withstands stone impact
- Scale shape reduces friction wear. Soil-to-soil contact that protects the point and reduces smear marks



3 DURASTAR PLUS points and wings

- High quality steel, the point and lower edge is completely encased with tungsten carbide. The point always sharpens itself
- Much longer service life and higher resistance to fracture for reliable operation
- Up to eight times more durable resulting in saving costs and time
- Improved penetration, lower power required thanks to optimised leading edge
- Optimum loosening and mixing through of soil
- Scale shape reduces friction wear. Soil-to-soil contact that protects the point and reduces smear marks



4 DURASTAR wing shares

- Coated on the underside of the share
- Double the durability compared to standard share
- Much higher wear resistance thanks to high quality steel that retains the shape
- Coating even withstands stone impact

5 DURASTAR PLUS wing shares

- Tungsten carbide plates along the shin of the wing
- 4 times the durability compared to standard wings



6 DURASTAR narrow point

- 40 mm wide without shin
- Reliable soil penetration and long service life thanks to tungsten carbide tip
- Intensive loosening up to 30 cm deep
- Effective breaking up of harmful compaction
- Promotion of soil rooting

Equipment versions for all types of soil

The two gang SYNKRO stubble cultivators are equipped as standard with split chisel points (CLASSIC) and wide wing shares.

It's your choice:

- CLASSIC point + shin + wing = standard
- CLASSIC point + shin on its own
- DURASTAR point + shin on its own
- DURASTAR point + shin + wing
- DURASTAR point + shin + DURASTAR wing
- DURASTAR point + shin + DURASTAR PLUS wing
- DURASTAR PLUS point + wing on its own
- DURASTAR PLUS point + shin + wing
- DURASTAR PLUS point + shin + DURASTAR wing
- DURASTAR PLUS point + shin + DURASTAR PLUS wing
- DURASTAR narrow point



Two-row mounted cultivators



SYNKRO 2520 / 3020 / 4020 K / 5020 K



Two-row mounted cultivators

Our compact two-row series operates smoothly at a low power requirement. An underframe clearance of 80 cm guarantees you trouble-free operation. These low draft and compact two-row cultivators are designed for lighter weight tractors with lower lifting capacity.

Two-row mounted cultivators



SYNKRO 2520 / 3020 / 4020 K / 5020 K



Adjustable headstock

The position of the SYNKRO headstock is adjustable on 3 m and 3.5 m versions, this enables an ideal match to your tractor. This optimised hitching geometry improves ground clearance on headland turns and during transport.

- Four top link positions
- As a result, the cultivator can be adapted to all sizes of tractor
- Two different mounting heights are possible thanks to the double clevis type mounting lugs. This is ideal when using the stubble cultivator with different tractors with different tyre dimensions



Compact frame

The compact frame is a trademark of the SYNKRO 1020 series. The first row of tines is very close to the tractor for a very favourable centre of gravity.

- The 100 x 100 mm fine-grained steel box section frame provides the highest strength
- 75 cm row spacing and 80 cm frame height guarantee maximum clearance
- The tapered frame design transfers the tractor's pulling power from the lower linkages up to the rear roller mountings

Two-row mounted cultivators

Folding



The wide models can be folded

The mounted cultivators with working widths of 4.0 m to 5.0 m can be folded together for road transport. The stubble cultivators are folded in two halves, resulting in maximum ground clearance even at low transport heights and a transport width of 3.0 m.

A safety interlock engages automatically using a hydraulically activated lock pin.

Two front support wheels (10/75-15.3) are available as an option to provide perfect depth control. Depth is adjusted using a ratchet turnbuckle on each side. Hydraulic depth adjustment is available as an option.

SYNKRO 4020 K / 5020 K



Easy adjustment

Working depth is adjusted quickly and easily using the rear roller. The working depth is indicated by the scale. Thanks to the tapered frame, the pin-in-hole system is easily accessible on both sides without risk to the operator.

- Only one adjustment point on each side
- The rear roller can be secured in place to transfer additional weight to the cultivator and improve penetration
- The rear roller can also move freely
- Hydraulic depth adjustment is available as an option

Proven components

The levelling discs are guided by the rear roller and adjusted in parallel. Their depth can also be adjusted in pairs. The scalloped shape ensures even better rotation through the soil.

- The sealed bearings are maintenance-free and do not need to be lubricated
- A labyrinth seal provides perfect protection for the bearing

Levelling tines are also available as an option in lieu of the discs.

The optional edging boards are mounted right next to the outer tines to deflect soil back under the rear roller and prevent ridges forming.

SYNKRO NOVA

Spring-mounted tines on SYNKRO NOVA stubble cultivators guarantee non-stop operation in stony soil.

- Two tine positions for reliable soil penetration
- The levelling discs are maintenance-free and mounted on rubber elements as protection against overloading
- Additionally, the tines are also protected by shear bolts
- As well as a stone protection system, PÖTTINGER also provides shear bolts. These protect the machines from larger rocks

Three-row cultivators



SYNKRO 3030 / 3530 / 4030 K / 5030 K



Three-row cultivators

SYNKRO three-row stubble cultivators are ideal for shallow stubble work and deep tillage. A central adjustment system allows you to adjust the working depth quickly and easily.

Three-row mounted stubble cultivators

Rigid and folding models



Rigid-framed mounted cultivators

SYNKRO 3030 / SYNKRO 3530

The compact frame is a trademark of the mounted stubble cultivators. The first row of tines is very close to the tractor for a very favourable centre of gravity.

Folding mounted cultivators

SYNKRO 4030 K / SYNKRO 5030 K

The folding mounted stubble cultivators can be folded vertically for road transport so that they are within 3.0 m and still have a low transport height. Once folded, high ground clearance is achieved and the folded wings are equipped with an automatic mechanical transport interlock.

SYNKRO 3030 / 3530 / 4030 K / 5030 K



Model overview

	Working width	Tines	Tine spacing	Power requirement from
Rigid-framed mounted cultivators				
SYNKRO 3030	3 m	11	27 cm	80 kW / 110 hp
SYNKRO 3530	3.5 m	12	28 cm	96 kW / 130 hp
Folding mounted cultivators				
SYNKRO 4030 K	4 m	14	28 cm	110 kW / 150 hp
SYNKRO 5030 K	5 m	18	28 cm	132 kW / 180 hp

Three-row mounted cultivators



SYNKRO 3030 / 3530 / 4030 K / 5030 K



NOVA stone protection system

SYNKRO NOVA models are equipped with overload protection. PÖTTINGER has completely updated the NOVA stone protection system and it now features a newly developed horizontal spring unit.

When obstacles are met at a depth of up to 30 cm, uninterrupted working is guaranteed by safe tripping and the large movement arc.

- The triggering force of 550 kg diminishes as the leg is raised, therefore stones are not pulled up or loosened. This protects both the cultivator and the tractor
- On SYNKRO NOVA models the first row of tines are located as far forward as possible to bring the weight as close as possible to the tractor
- Two tine positions for reliable soil penetration
- Additionally, the tines are also protected by shear bolts

Proven components

The levelling discs on SYNKRO NOVA models are also equipped with maintenance-free stone protection.

- Proven over many years in the field, the stone protection system features 40 mm thick rubber element.
- The sealed bearings are maintenance-free and do not need to be lubricated
- A labyrinth seal provides perfect protection for the bearing

Levelling tines are also available as an option in lieu of the discs.

Three-row mounted cultivators



SYNKRO 3030 / 3530 / 4030 K / 5030 K



Adjustable headstock

Tractors with up to 190 hp have a huge range of hitch geometries. Reliable soil penetration performance and excellent working results are still achieved.

Mounting category on three-row mounted cultivators: Cat. II / 2.

SYNKRO 3030 / SYNKRO 3530

Two lower linkage mounting heights with clevis-type lower linkage mountings. The headstock angle can be adjusted and with three top linkage positions optimum adaptation to any tractor is guaranteed.

- Headstock vertical = standard setting
- Headstock angled forward for tractors with short top links
- Headstock can be lowered for smaller tractors

SYNKRO 4030 K / SYNKRO 5030 K

On the folding models, the headstock provides three top link and two lower linkage mounting heights.

Mounting category on three-row, folding cultivators: Cat. III / 2, Cat. III / 3.

Heavy duty frame

The compact frame is a trademark of mounted SYNKRO stubble cultivators. The first row of tines is very close to the tractor for a very favourable centre of gravity.

- 100 x 100 mm box section frame made from fine-grained steel gives the greatest stability
- The tapered frame design transfers the tractor's pulling power from the lower linkages right up to the rear roller mountings
- Thanks to the tapered frame the depth adjustment system is easily accessible on both sides without risk to the operator

Cover crop sowing unit



Helps you save time

The TEGOSEM cover crop sowing unit combines soil cultivation and sowing a catch crop in a single pass to save time and costs. The TEGOSEM can be combined with PÖTTINGER TERRADISC disc harrows as well as with SYNKRO stubble cultivators. This sowing unit can be used together with three-point mounted implements and trailed machines.

TEGOSEM can be combined with SYNKRO stubble cultivators

Stubble cultivators	Mounting	TEGOSEM	Fan drive	Position	Volume	TEGOSEM weight
SYNKRO 2520	Three-point, rigid	TEGOSEM 200	Electric	Rear roller	200 l	135 kg
SYNKRO 3020	Three-point, rigid	TEGOSEM 200	Electric	Rear roller	200 l	135 kg
SYNKRO 3030	Three-point, rigid	TEGOSEM 200	Electric	Rear roller	200 l	135 kg
SYNKRO 3530	Three-point, rigid	TEGOSEM 200	Electric	Rear roller	200 l	135 kg



Precision sowing

The seed material is distributed evenly with the TEGOSEM. The metering system is driven electrically. Two different metering shafts are provided as standard to ensure precision distribution for fine or coarse metering, even at low seed flow rates. Eight outlets ensure precise seed distribution.



Calibration

the calibration procedure is started at the press of a button. A logical guide makes each calibration step easy to follow. A calibration bag is provided as standard equipment.

Seed distribution

The seed material is distributed pneumatically using distribution plates. This guarantees pinpoint precision regardless of the wind conditions. The distributor plates are adjusted by changing the shaft angle.



Metering start/stop

A sensor on the top link detects when to start and stop metering.

Cover crop sowing unit





Standard equipment and controls

The TEGOSEM is operated from the driver's seat using a convenient control terminal.



DGPS sensor

- DGPS sensor for speed sensor
- One rough seed and one fine seed metering wheel are supplied with the drill as standard.



Electric or hydraulic fan drive system

The fan is driven electrically up to a working width of 4.0 metres and hydraulically when wider than 5.0 metres.

Functions

- Metering shaft control & monitoring, Output rate electronically adjustable
- Display in kg/ha
- Priming function
- Headland management
- Automatic calibration
- Total hectare counter and daily hectare counter
- Calibration button -calibration at the press of a button
- Emptying function to drain seed hopper
- Filling level sensor
- Sensors on top link or chassis for start/stop metering
- Safe access using platform

For perfect results



Requirements	Cage roller	Double cage roller	Knife ring roller	Pack ring roller	ROTOPACK roller	Rubber packer roller	CONOROLL roller	TANDEM CONOROLL roller
Consolidation	o	o	+	++	-	++	+	++
Damp conditions	o	o	o	++	o	+	++	+
Dry conditions	++	++	++	++	+	++	++	++
Crumbling effect	+	++	++	++	++	++	++	++
Load capacity	+	++	+	++	+	++	+	++
Self-propulsion	++	++	+	++	++	+	+	++
Suitability for stones	+	o	-	++	-	o	++	++
Scraper	no	no	yes	yes	no	yes	yes	no
Tare weight in kg for 3 m working width	325	520	420	595	400	560	430	685
Diameter in mm	540 / 660	540 / 420	540	550	545	590	540	560

- ++ highly suitable
- + very suitable
- o suitable
- not suitable



Wide range of rear rollers

It's your choice. PÖTTINGER offers a wide range of rear rollers for perfect results with the desired tilth in any type of soil.

The whole range of rollers features precision manufacturing and robust design engineering.

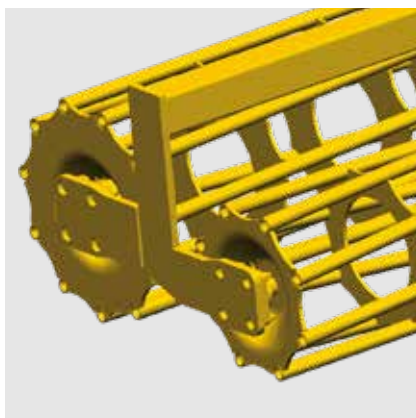
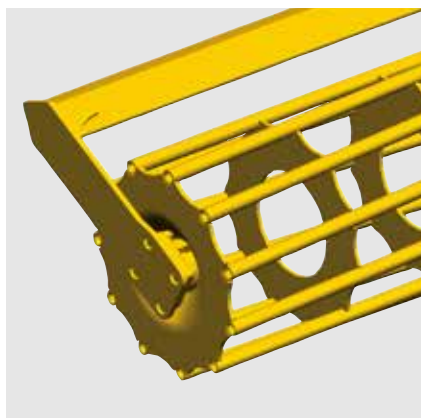

Cage roller

The ideal roller for dealing with dry, non-sticky soils. The roller is fitted with strong bars for optimal consolidation.

Diameter 540 mm, 11 bars; diameter 660 mm, 12 bars.

Double cage roller

The double cage roller is fitted with two different diameter rollers (540 mm front and 420 mm rear). The pendular function ensures optimum ground tracking and perfect tilth.

Knife ring roller

The advantages of the knife ring roller with a diameter of 540 mm include enhanced tilth and consolidation by means of wedge-shaped rings.

The knives between the rings break up clods and keep the rings clean. Consolidated ridges have the advantage that water can be absorbed better. The right choice if you are working on dry and heavy soil.

For perfect results



Pack ring roller

The enclosed packer rings consist of 550 mm diameter with eight rings per metre of working width. The roller leaves behind consolidated ridges, promoting drainage and soil respiration. This is the ideal roller on stony, damp ground with large quantities of organic matter. The scrapers are coated for an extended working life.

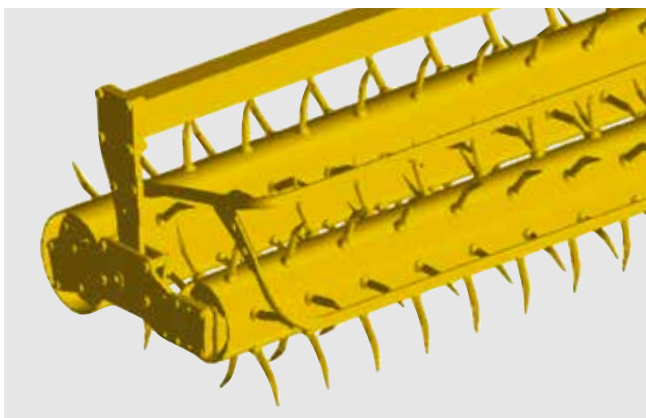

Rotopack roller

Rotopack rollers mix intensively and are suited for light to heavy, non-sticky soils. Weeds are uprooted and brought up to the surface to dry out. Only available in 3.0 m working width.



Rubber packer roller

The perfect roller for widely varied soil conditions. With a diameter of 590 mm and the special profiling allows the soil to be consolidated in ridges. The scrapers are coated for an extended working life.

Rear rollers

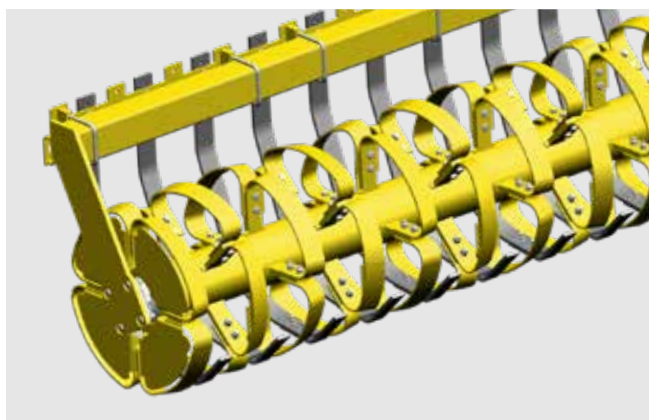

CONOROLL roller

This roller consists of rings with a diameter of 540 mm. Each ring is made up of four conical segments that are offset to the left and right. The result is a slot with alternate indentations on either side. When rainwater seeps into these indentations, they prevent it from flowing away. Erosion caused by rainfall is minimised thanks to the optimum structure created on the soil surface. The loose soil between the rings ensures good drainage.

The gap between each ring is 20 cm. Located between each ring is a spring-mounted scraper which promotes the formation of a fine tilth, whilst keeping the space between the rings clean.

The load-bearing capacity of the CONOROLL is limited on very light soil. This is an ideal roller for medium to heavy soils. The outer segments of the roller are covered, this guarantees trouble-free operation in harvest residues and stones.

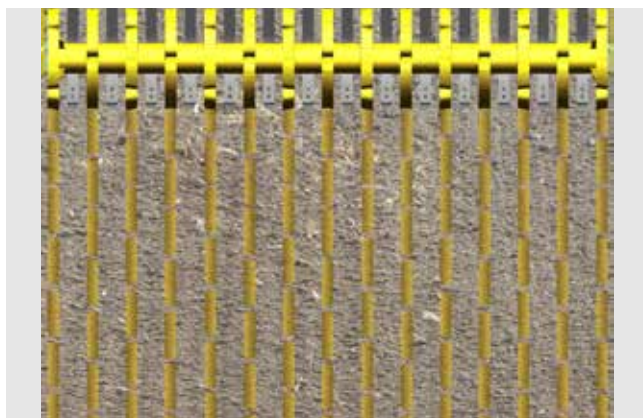

Tandem CONOROLL roller

The tandem CONOROLL consists of 2 rollers. The diameter of the rings is 560 mm with a strip thickness 8 mm.

- The TANDEM CONOROLL provides good load-bearing capacity. This is achieved by the two rollers, each with a contact area of 50% rotating one inside the other. Consequently, this rear roller is also suitable for light soils.
- The angle of the rear roller can be adjusted depending on the working depth and operating conditions.
- The rollers self-clean effectively; no scrapers required.

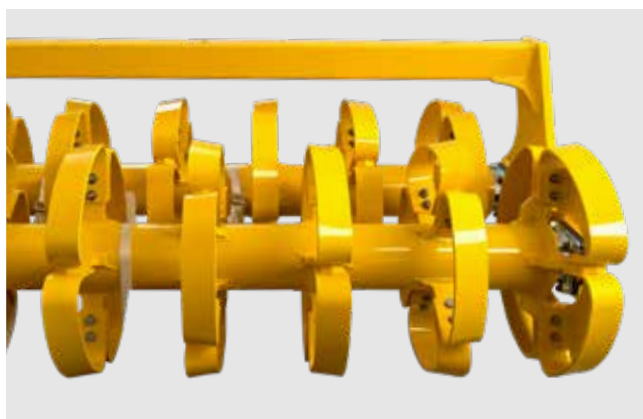

Equipment options





Levelling tines

The levelling tines are a lighter and cost-effective alternative to levelling discs. These are ideal for use in moderate amounts of harvest residues and finely chopped straw.

- For all three-point linkage mounted SYNKRO's
- Individually suspended tines
- Height and inclination adjustment



Rear harrow

Optional for three-point linkage mounted SYNKROs. The rear harrow leaves a finely-crumbled surface. The ridges created by rear rollers are levelled to prevent ponding. Harvest residues are placed lightly on the surface to provide ideal germination conditions for weeds and volunteers. Available with knife ring roller, pack ring roller, rubber packer roller and CONROLL roller.



DRILLBOX

Cover crop seed drill for SYNKRO 2520, 3020 and 3030

- Main adjustment with a lever, fine adjustment with a screw adjuster
- Scattering plates for even distribution
- Optional agitator for seed mixtures
- Driven by land wheel
- Catchment tray for calibration

Accessories

Two-gang mounted cultivators



Narrow point



DURASTAR chisel point



DURASTAR PLUS chisel point



DURASTAR PLUS Cultivator wing



Edging board left / right

SYNKRO 2520	<input type="checkbox"/>	<input type="checkbox"/>	<input type="checkbox"/>	<input type="checkbox"/>	<input type="checkbox"/>
SYNKRO 3020	<input type="checkbox"/>	<input type="checkbox"/>	<input type="checkbox"/>	<input type="checkbox"/>	<input type="checkbox"/>
SYNKRO 4020 K	<input type="checkbox"/>	<input type="checkbox"/>	<input type="checkbox"/>	<input type="checkbox"/>	<input type="checkbox"/>
SYNKRO 5020 K	<input type="checkbox"/>	<input type="checkbox"/>	<input type="checkbox"/>	<input type="checkbox"/>	<input type="checkbox"/>

Three-row cultivators



Narrow point



DURASTAR chisel point



DURASTAR PLUS chisel point



DURASTAR PLUS cultivator wing



Edging board left / right

SYNKRO 3030	<input type="checkbox"/>	<input type="checkbox"/>	<input type="checkbox"/>	<input type="checkbox"/>	<input type="checkbox"/>
SYNKRO 3530	<input type="checkbox"/>	<input type="checkbox"/>	<input type="checkbox"/>	<input type="checkbox"/>	<input type="checkbox"/>
SYNKRO 4030 K	<input type="checkbox"/>	<input type="checkbox"/>	<input type="checkbox"/>	<input type="checkbox"/>	<input type="checkbox"/>
SYNKRO 5030 K	<input type="checkbox"/>	<input type="checkbox"/>	<input type="checkbox"/>	<input type="checkbox"/>	<input type="checkbox"/>

Often ordered together

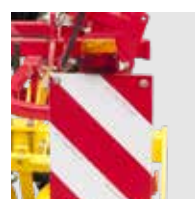
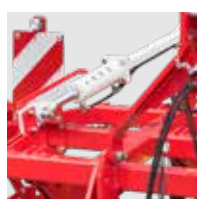
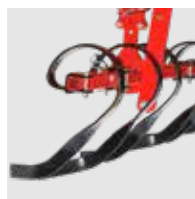

Rear harrow

Levelling tines

Hydraulic depth adjustment

Tine transport protection

Warning signs with Lighting

Support wheels 10/75-15.3

<input type="checkbox"/>	<input type="checkbox"/>	<input type="checkbox"/>	-	<input type="checkbox"/>	-
<input type="checkbox"/>	<input type="checkbox"/>	<input type="checkbox"/>	<input type="checkbox"/>	<input type="checkbox"/>	-
<input type="checkbox"/>	<input type="checkbox"/>	<input type="checkbox"/>	<input type="checkbox"/>	<input type="checkbox"/>	<input type="checkbox"/>
<input type="checkbox"/>	<input type="checkbox"/>	<input type="checkbox"/>	<input type="checkbox"/>	<input type="checkbox"/>	<input type="checkbox"/>

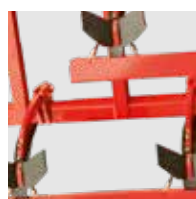
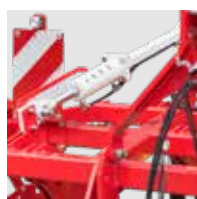
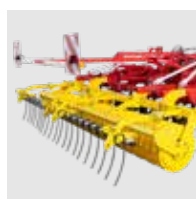

Rear harrow

Levelling tines

Hydraulic depth adjustment

Tine transport protection

Warning signs with Lighting

10/75-15.3 support wheels for K models

<input type="checkbox"/>	<input type="checkbox"/>	<input type="checkbox"/>	<input type="checkbox"/>	<input type="checkbox"/>	-
<input type="checkbox"/>	<input type="checkbox"/>	<input type="checkbox"/>	<input type="checkbox"/>	<input type="checkbox"/>	-
<input type="checkbox"/>	<input type="checkbox"/>	<input type="checkbox"/>	<input type="checkbox"/>	<input type="checkbox"/>	<input type="checkbox"/>
<input type="checkbox"/>	<input type="checkbox"/>	<input type="checkbox"/>	<input type="checkbox"/>	<input type="checkbox"/>	<input type="checkbox"/>

More equipment options

- DRILLBOX cover crop drill (SYNKRO 2520 / 3020 / 3030)
- TEGOSEM cover crop sowing unit SYNKRO rigid

■ = Standard, □ = Optional

Technical data

SYNKRO / SYNKRO NOVA	2520	3020	4020 K	5020 K
Mounting	Cat. 2 / 2	Cat. 2 / 2	Cat. 3 / 3	Cat. 3 / 3
Working width	2.5 m	3.0 m	4.0 m	5.0 m
Transport width	2.5 m	3.0 m	3.0 m	3.0 m
Tines	6	7	9	11
Levelling discs	5	6	9	10
Tine spacing	42.5 cm	42 cm	44 cm	45 cm
Box section frame			100 x 100 mm	
Inter gang spacing			75 cm	
Frame height			80 cm	
Power requirement from	51 kW / 70 hp	66 kW / 90 hp	103 kW / 140 hp	110 kW / 150 hp
SYNKRO base weight	690 kg	795 kg	1380 kg	1755 kg
SYNKRO NOVA base weight	930 kg	1050 kg	1695 kg	2130 kg

SYNKRO rear roller	2520	3020	4020 K	5020 K
Cage roller 540 mm	280 kg	325 kg	480 kg	619 kg
Cage roller 660 mm	317 kg	425 kg	610 kg	766 kg
Double cage roller	–	–	–	–
Knife ring roller	360 kg	420 kg	610 kg	720 kg
Pack ring roller	500 kg	595 kg	820 kg	1010 kg
Rubber packer roller	505 kg	560 kg	–	1000 kg
CONOROLL roller	370 kg	430 kg	620 kg	740 kg
Tandem CONOROLL roller	–	685 kg	950 kg	1160 kg
Rotopack roller	–	400 kg	–	–

3030	3530	4030 K	5030 K
Cat. 2 / 2	Cat. 2 / 2	Cat. 3 / 2 / 3	Cat. 3 / 2 / 3
3.0 m	3.50 m	4.0 m	3.0 m
3.0 m	3.50 m	3.0 m	3.0 m
11	12	14	18
6	7	8	11
27 cm	28 cm	28 cm	28 cm
80 kW / 110 hp	96 kW / 130 hp	110 kW / 150 hp	132 kW / 180 CV
1020 kg	1160 kg	1825 kg	2940 kg
1390 kg	1540 kg	2355 kg	3080 kg

3030	3530	4030 K	5030 K
325 kg	–	480 kg	619 kg
425 kg	–	610 kg	766 kg
520 kg	–	760 kg	880 kg
420 kg	470 kg	610 kg	720 kg
595 kg	710 kg	820 kg	1010 kg
560 kg	–	–	1000 kg
430 kg	510 kg	620 kg	740 kg
685 kg	–	950 kg	1160 kg
400 kg	–	–	–

*Our SYNKRO models output their full working width in the field.

All machine information at a glance

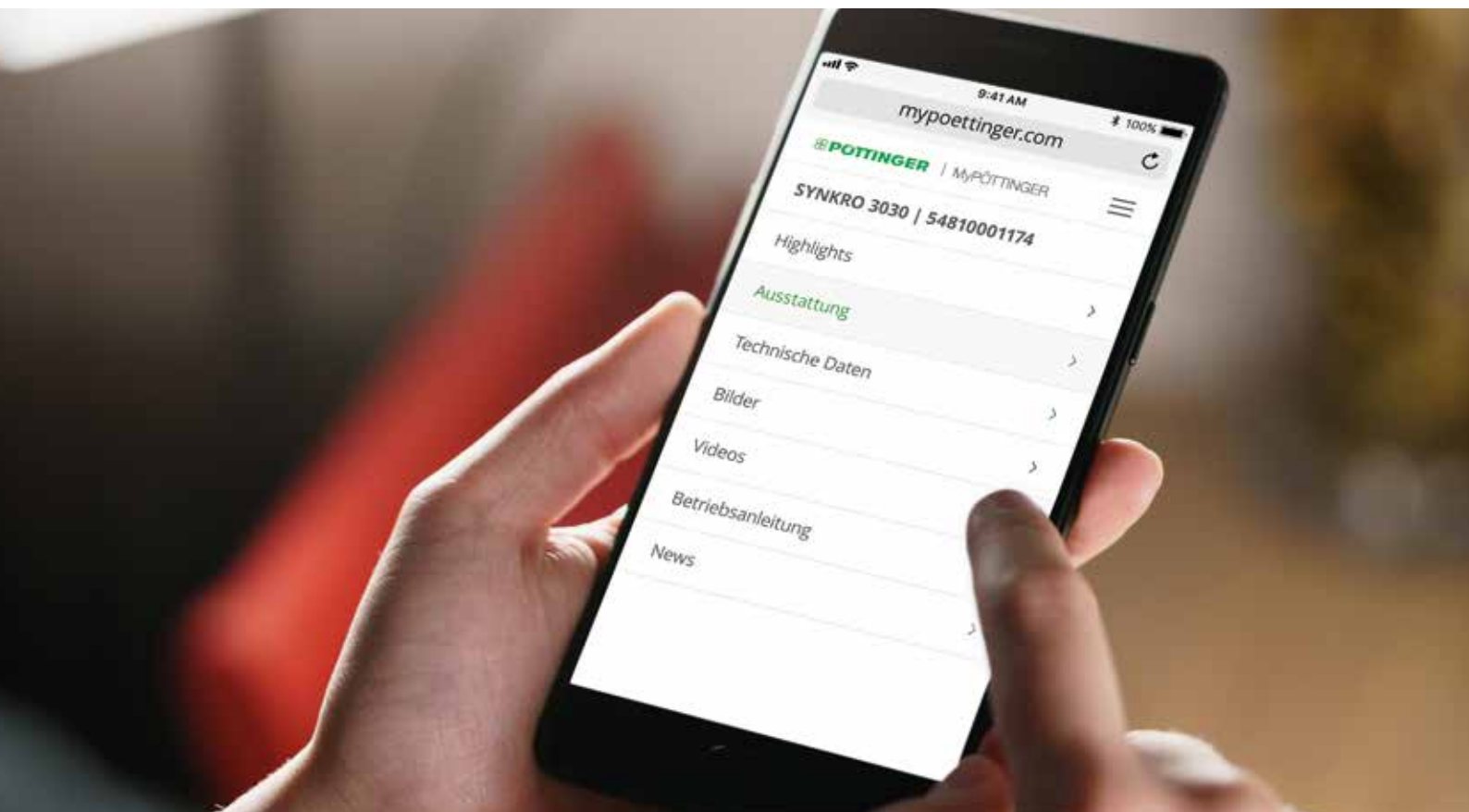

MyPÖTTINGER – Simple. Anytime. Anywhere.

For all PÖTTINGER machines 1997 models onwards

We have created MyPÖTTINGER as a tool to provide machine specific information for all machines from year of build 1997 onwards.

Simply scan the QR code on the data plate with your smartphone or tablet or enter your machine number at www.mypoettinger.com.

Your machine goes online

You will immediately receive all the information on your machine.

- Instruction manual
- Optional equipment information
- Brochures
- Photos and videos.

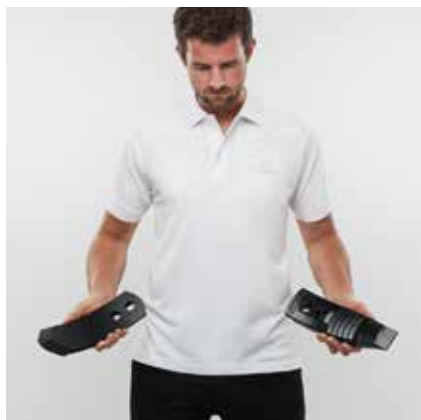

Rely on the original

PÖTTINGER Original Parts meet the highest demands in terms of functionality, reliability and performance. These are characteristics that PÖTTINGER is committed to delivering.

That is why we manufacture PÖTTINGER Original Parts from the highest quality materials. We ideally match each individual spare part and wear part to your machinery's overall system. This is because different soil and operating conditions often need to be taken into consideration.

We have been listening to our customers and now offer three different lines - CLASSIC, DURASTAR and DURASTAR PLUS - to make sure you have the right part to meet every requirement. Original parts are worth every cent, because know-how cannot be copied.

Your advantages

- Immediate and long-term availability.
- Maximum durability thanks to innovative production processes and the use of the highest quality materials.
- Avoidance of malfunctions due to a perfect fit.
- The best working results thanks to optimum match to the overall system of the machine.
- Save time and costs thanks to longer replacement intervals on wear parts.
- Comprehensive quality testing.
- Ongoing advancement through research and development.
- Worldwide spare parts supply.
- Attractive, competitive prices for all spare parts.

Wear parts

The CLASSIC line is for standard duty applications. With these ORIGINAL INSIDE parts we have defined the benchmark for quality, best price/performance ratio and reliability.

DURASTAR is the innovation on the wear components market - durable, high quality, productive and reliable.

Are you used to putting your machines to work in the most extreme conditions? Then the DURASTAR PLUS line is the right choice for you.



More Success with PÖTTINGER

- A family-owned company since 1871
Your reliable partner
- Specialist for tillage, seed drills
Hay and harvesting machines
- Future-safe innovation for outstanding working results
- Roots in Austria - at home throughout the world

You can rely on our SYNKRO

- High clearance – incorporation of large quantities of harvest residues as well as perfect mixing
- Total versatility thanks to a wide range of settings for the perfect working results
- High durability thanks to the robust frame construction of SYNKRO stubble cultivators
- Significantly longer service life thanks to high-quality armoured tillage tools and DURASTAR points and wings
- Trust in PÖTTINGER for harvest success

Ask for more information:

PÖTTINGER Landtechnik GmbH

Industriegelände 1
4710 Grieskirchen
Austria
Phone +43 7248 600-0
info@poettinger.at
www.poettinger.at

Alois PÖTTINGER UK Ltd.

15 St Marks Road, Corby
Northamptonshire,
NN18 8AN
United Kingdom
Phone + 44 1536 272 220
info@pottinger.uk
www.pottinger.uk

POETTINGER Canada Inc.

460 Rue Robinson Sud
Granby, QC, J2G 7N6
Canada
Phone +1 450 372 5595
Fax +1 866 417 1683
info@poettinger.ca
www.poettinger.ca

POETTINGER US, Inc.

393 Pilot Drive
Valparaiso, IN 46383
USA
Phone +1 219 510 5534
Fax + 1 219 707 5412
info@poettinger.us
www.poettinger.us

PÖTTINGER Australia PTY LTD

11 Efficient Drive
Truganina VIC 3029
Australia
Phone +61 3 8353 2770
info@poettinger.com.au
www.poettinger.com.au

POETTINGER Ireland Ltd.

Glenaleamy, Powerstown Road,
Clonmel, Co. Tipperary
Ireland
Phone +353 52 6125766
info@poettinger.ie
www.poettinger.ie

Importer for New Zealand:

Origin Aggroup
PO Box 673, 57 Hautapu Road
Cambridge
New Zealand
Phone +64 7 823 7582
info@originagroup.co.nz
www.originagroup.co.nz

Importer for South Africa:

VALTRAC
Cnr. Water & Buiten Street
9585 Parys
South Africa
Phone +27 56 817 7338 7308
wynn@valtrac.co.za
www.valtrac.co.za