

MINI EXCAVATORS



Concrete solutions. Always.

22SR

Operative weight 2.090 - 2.190 kg
Maximum power 15,4 kW - 20,9 HP

 **EUROCOMACH**[®]

With the new, more accessible and spacious cabin, the 22SR offers the same performance of larger machines. It's a short radius and agile machine, ideal for working in limited spaces.



300 mm



SHORT RADIUS

With its enlarged undercarriage, the rear extension is cut to a minimum (300 mm), meaning that it can also operate in very limited spaces.

LIKE THE BIG ONES BUT SMALLER.

DIMENSIONS

With its extendible undercarriage from 990 to 1,300 mm, the 22SR is an ultra-compact machine.

The smallest width allows it to operate in narrow spaces while the biggest guarantees even more stability and safety for the operator.



The 22SR can be configured with a protective canopy with four uprights or a cabin.

DESIGNED AROUND THE OPERATOR.



Thanks to the wide entry point (550 mm), the operator can get comfortably in and out of the cabin with the guaranteed accessibility of larger machines.



ACCESSIBILITY

The flat, obstacle-free floor facilitates for the operator and simplifies cabin cleaning.

A NEW LEVEL OF COMFORT.

The new cabin has been designed to provide the operator with maximum comfort. The cushioned, adjustable seat absorbs vibrations and jolting of the machine.



COMFORT

To minimise vibrations while working and in transit, the cabin is installed on four rubber, anti-vibration, silent blocks.

EVERY COMMAND IS IN YOUR HANDS.



COMMANDS AND CONTROLS

The 22SR has two travel modes: the first gear with reduced speed and high thrust, the second gear for faster travel speed; all controlled by a handy button on the dozer blade lever.

The travel can be controlled by the integrated movement levers and pedals.

The automatic two-speed gearbox intervenes when the excavator requires greater thrust: the shift from second to first gear occurs automatically when the work pressure increases (e.g. When steering on very muddy ground or when pushing with the blade). The system switches back to second gear when work conditions allows it again.



STRAIGHT TRAVEL

If travel and service commands are given together, the hydraulic system with variable rate pump guarantees fluid movements and straight travel of the machine at the same time.

AN EXCELLENT OVERVIEW OF THE WORKSITE.



VISIBILITY

The specific design of the bodywork and protective structure guarantee to the operator an extra-wide field of vision which allows him to easily control the overall size of the rear part of the track.

The seat is not only comfortable but also provides more leg space thanks to the new cabin, so the operator is free to work unhindered with an excellent overview of the worksite.



The side sliding window and liftable front windscreen (with gas springs) guarantee maximum visibility to the operator. The lower part of the windscreen slides into the frame of the upper section. Both sections, therefore, are lifted and placed on the roof, allowing the operator to increase the ventilation and visibility of the machine.



WORK LIGHTS

A powerful LED spotlight installed on the boom increases visibility when working in poor lightning conditions.

POWERFUL, HIGH-PERFORMANCE, SUPERIOR CATEGORY.

EFFICIENCY AND CONSUMPTION

The KUBOTA D1105 (1.100 cc) combustion engine produces 15.4 kW of power. The engine is installed in a handy position for maintenance work and complies with European Stage V emission standards, allowing the machine to achieve a high operating level whilst increasing the efficiency and cutting consumption.

The long intervals between scheduled maintenance work contribute towards economic efficiency, cutting the costs of machine downtime. All the access points for daily checks and regular maintenance work can be easily accessed and are concentrated in specific areas.



SAFETY

Machine safety means operator's peace of mind: the joystick control sensors prevent accidental machine commands being given while the excavator starter system does not allow ignition when the command control is active.

The safety belts, the cabin and roll-bar structure, FOP level 1 and TOPS certificated, provide all the safety required in the cabin in the event of an accident.

LOAD-SENSING HYDRAULIC SYSTEM.

The 22SR is fitted with a Load Sensing system thanks to which the LS pump only feeds the flow rate requested by the system while the Flow Sharing distributor allows multiple movements to be carried out at the same time, even when the flow rate request exceeds the pump's maximum flow rate.

The pressure compensators on each section of the hydraulic system guarantee an optimal flow rate on each element. The machine offers high speed movements when unloaded and high pressure when working via the flow rate and pressure regulators.

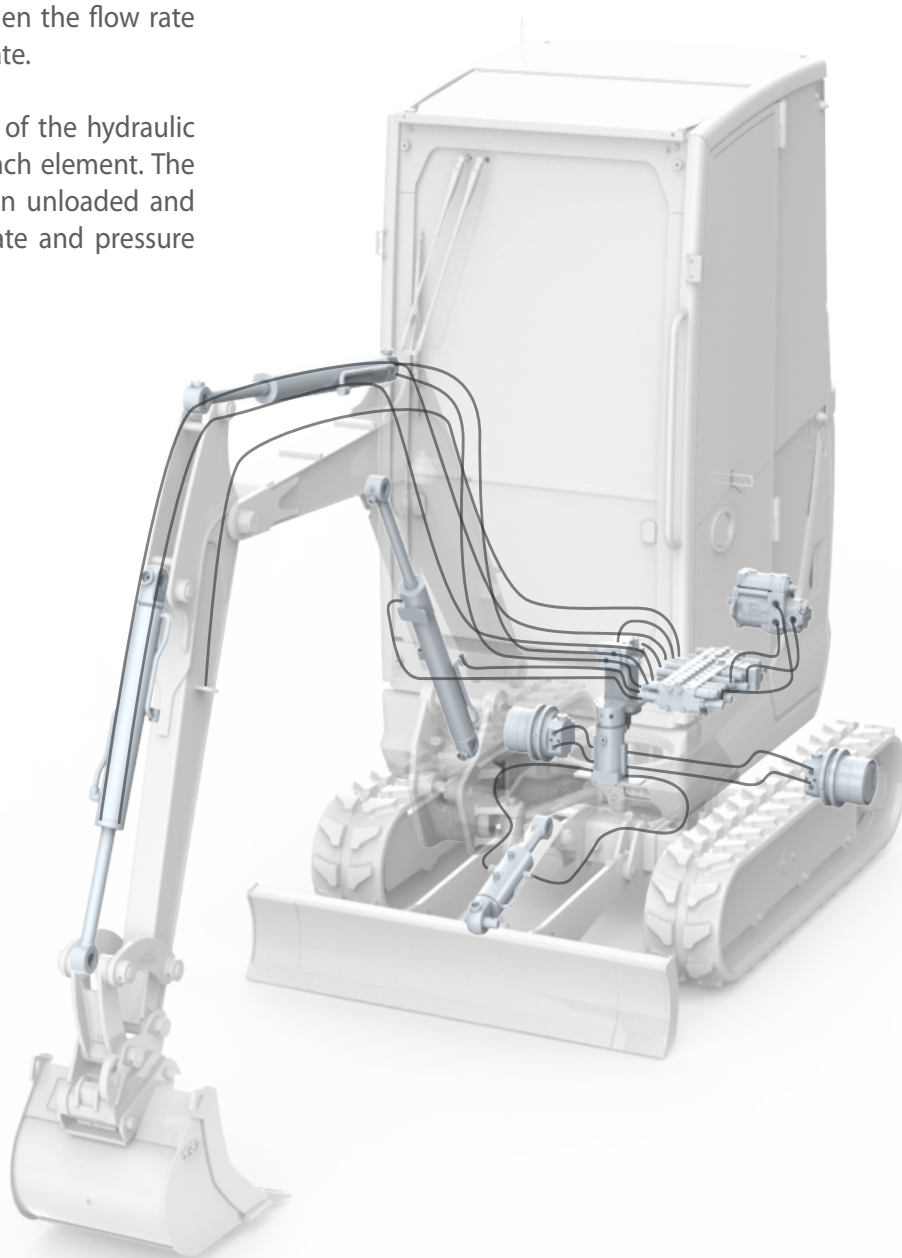

SAVINGS

Thanks to a suitable power distribution, the Load Sensing system allows for up to 15% fuel savings.

MAINTENANCE HAS NEVER BEEN SO EASY.

The fast and handy cabin tilting mechanism provides easy access to the distributor and main components of the hydraulic system: a few steps for a significant added value.

The cabin can be lifted up by simply opening the front hood and removing the two fastening screws.



INTEGRATED TANK

The diesel tank is conveniently integrated into the rear hood of the machine.

The large diesel tank, integrated into the rear bonnet, provides easy access and state of the art standard maintenance above that for this category.

Opening the bonnet provides quick access to all the combustion engine filters (diesel, oil and air) as well allow the diesel and motor oil to be topped up.

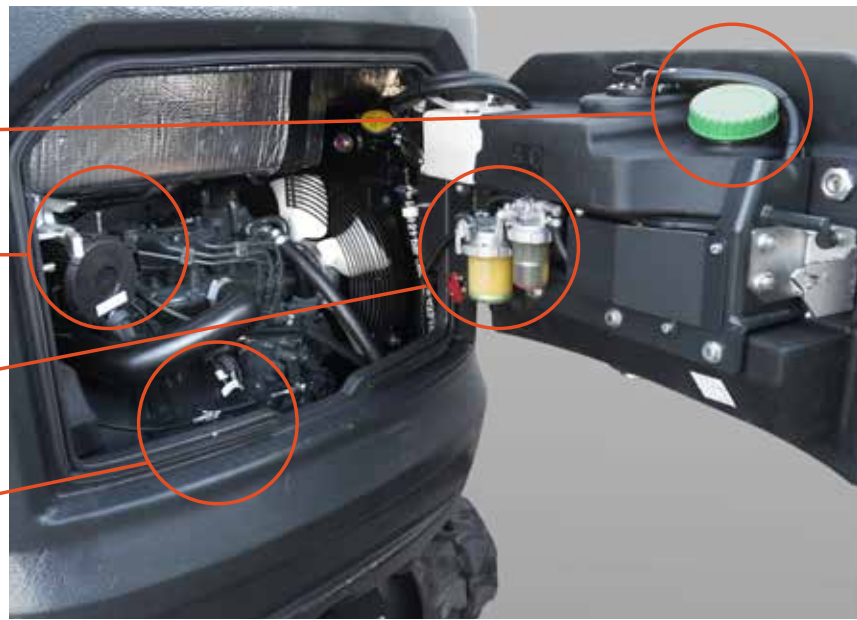

The side bonnet can be opened allowing the radiators and hydraulic oil filter to be inspected and cleaned.



All the access points for daily inspections and ordinary maintenance interventions are concentrated in defined areas, making the most of machine stop time.

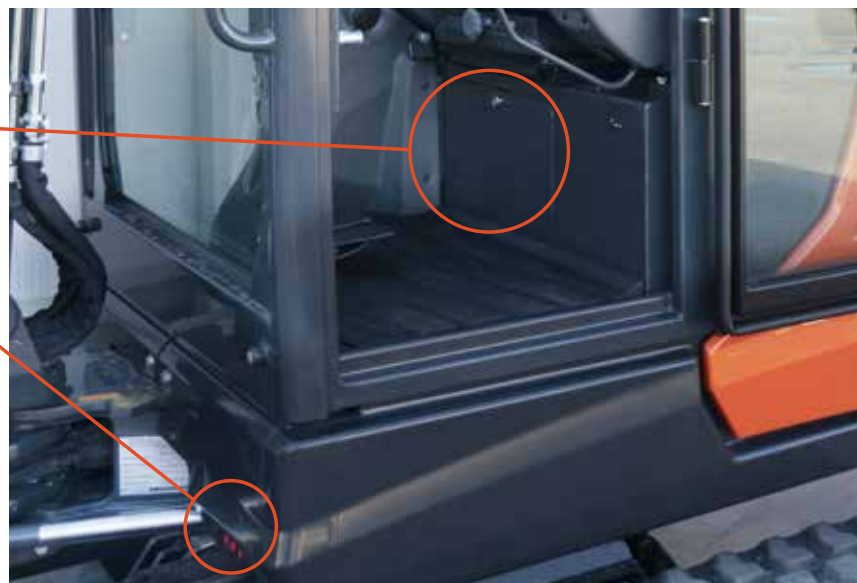

ACCESSIBILITY

Common or dedicated access makes all servicing operations simple and quick.

SPACE AT YOUR DISPOSAL.

In both layouts, with either roll-bar or cabin, the 22SR is fitted with a spacious and handy rear glove box, ideal for storing the machine documentation and the regular maintenance kit.

In the layout with the cabin, the machine can be fitted with an air-conditioning system to allow the operator to work in comfort even when it is very hot outside. The system is fitted in the rear cabin compartment which makes it easy to access and does not interfere with the comfort of the cabin.



CANOPY VERSION



CAB VERSION



HEATING AND COOLING SYSTEM

The air vents are laid out so they provide rapid and even cooling.

DEVELOPED TO OFFER THE BEST PERFORMANCE.

In the standard layout, the arm provides the 22SR with exceptional performance levels: an excavation depth of 2,560 mm and a reach of 2,760 mm with the optional arm.



2.560 mm
(2.760 mm)

TRANSPORT ACCESSIBLE TO EVERYONE.

The compact dimensions and overall weight under 2.5 tons means it can be loaded on a trailer and transported along with other equipment and accessories.



TRANSPORTATION

The machine has four anchoring points on the tower frame which allow it to be safely transported.

EUROCOMACH CONFIGURATION SUPPORT (ECS): ENDLESS CUSTOMISATION POSSIBILITIES.

We offer a complete customisation service, offering our customers the right machine for their needs. Some of our most requested services:

- Customized paintwork
- Configuration of additional auxiliary lines
- Numerous assortment of additional equipment
- Various types of tracks



EUROCOMACH GEO-SERVICE.

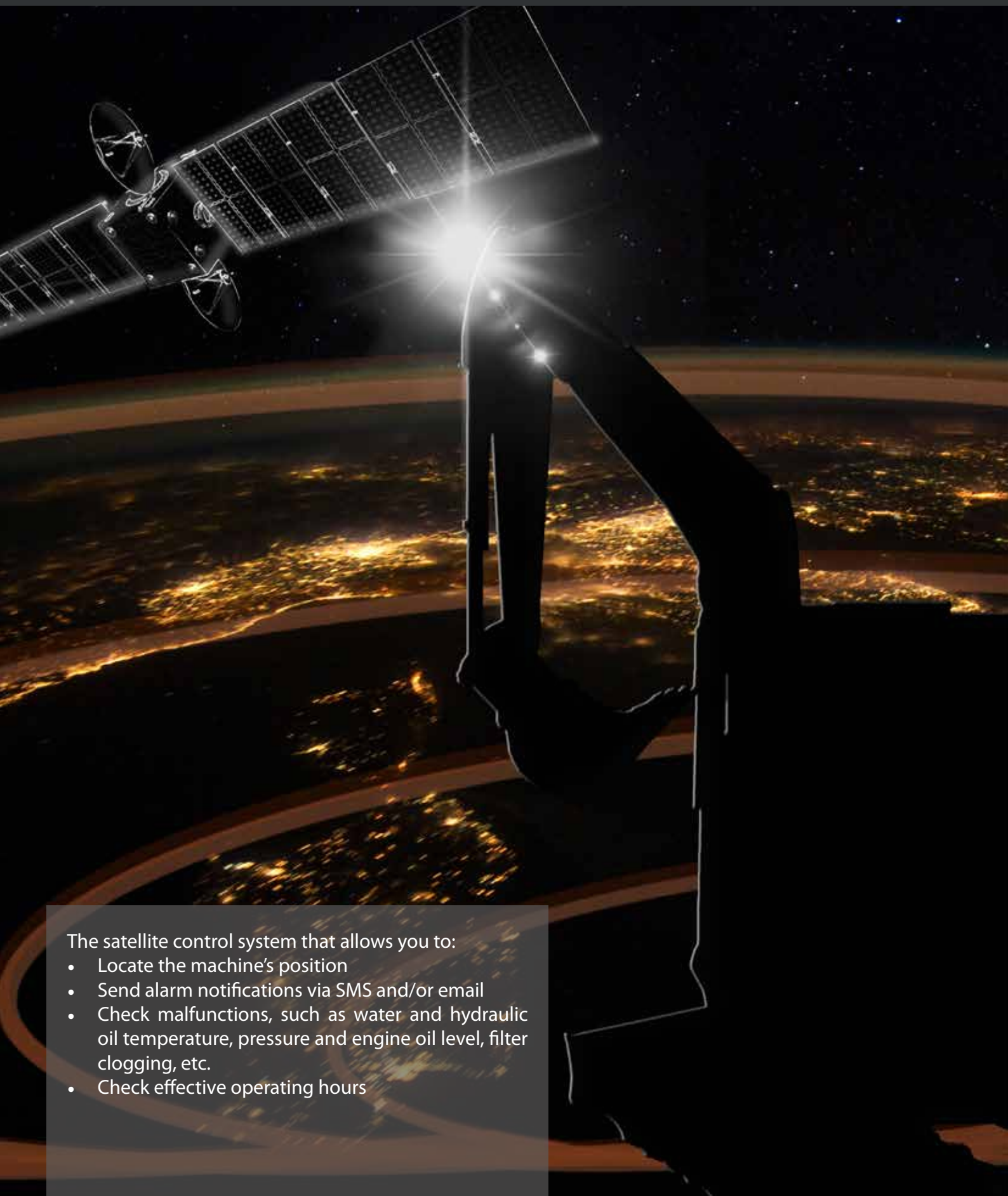

The satellite control system that allows you to:

- Locate the machine's position
- Send alarm notifications via SMS and/or email
- Check malfunctions, such as water and hydraulic oil temperature, pressure and engine oil level, filter clogging, etc.
- Check effective operating hours

22SR	
ENGINE	
Diesel motor, 3 cylinders, 1,105 cc capacity, water cooled	●
Electric pre-warming	●
Dry air filter with discharge valve and indication of filter blockage	●
Double air filter cartridge	●
Engine oil cartridge filter	●
Cartridge fuel filter	●
Fuel filter with transparent water separation tray	●
Fuel tank discharge hatch	●
Auxiliary cooling liquid expansion tray	●
CANOPY	
Rollbar 4 uprights ROPS - TOPS - FOPS (Level 1)	●
Adjustable mechanical suspension seat	●
Adjustable pneumatic suspension seat	○
Seat belt	●
Wrist supports	●
Footrests	●
Rubber comfort foot board	●
Driver's seat platform assembled on 4 elastic supports for cushioning vibrations	●
Warning light for hydraulic filter and blockage of air engine intake filter	●
Water temperature and fuel level indicators	●
Hour meter	●
Acoustic warning for water temperature	●
Horn	●
Unipolar 12 Volt power socket	●
Glove box	●

22SR	
INTERFACE	
Cabin ROPS - TOPS - FOPS (Level 1)	○
Adjustable mechanical suspension seat	●
Adjustable pneumatic suspension seat	○
Seat belt	●
Wrist supports	●
Footrests	●
Rubber comfort foot board	●
Driver's seat platform assembled on 4 elastic supports for cushioning vibrations	●
Heating system with speed adjustment	●
Right sliding side window	●
Windscreen with aided opening system (gas springs)	●
Roll-up sunshade	●
Courtesy light	●
Warning light for hydraulic filter and blockage of air engine intake filter	●
Water temperature and fuel level indicators	●
Hour meter	●
Acoustic warning for water temperature	●
Horn	●
AM/FM USB Radio	○
Unipolar 12 Volt power socket	●
Glove box	●
Front windscreen wipers with washer jet and speed adjustment	●
SAFETY	
Machine blocking device during exit/access to driving seat	●
Motor starter device only with left console raised	●
Non-slip boarding step	●
Boarding and de-boarding handles	●
Emergency water sprinkler	●
Rear view mirror kit	●
Anti-yaw safety valve on first arm, second arm and backfill blade	○
Pressure accumulator that permits the lowering of the arm in case of engine failure	●

22SR	
HYDRAULIC SYSTEM	
LS Flow-Sharing hydraulic system with variable flow rate pump	●
ISO hydraulic servo-controls	●
Hydraulic oil intake filter	●
Rotation lock parking brake	●
Parking brake	●
Two speed travel system	●
Automatic shift-down	●
Single/double effect hydraulic system (e.g. demolition or auger) with electric cable	●
Hydraulic set-up for grapple rotor (with cocks on bucket cylinder)	○
Hydraulic set-up for cutting head (with additional pump)	○
AUX 2: Dual acting, low flow rate hydraulic set-up with potentiometer control on left joystick (excludes boom swing)	○
ELECTRICAL SYSTEM	
Work lights on the lifting arm	●
Additional front canopy/cabin lights	○
Additional rear canopy/cabin lights	○
Rotating head lamp	○
Battery disconnection switch	●
Sealed connectors (IP67)	●
UNDERCARRIAGE	
Backfill blade	●
Dozer blade cylinder protective casing	●
Drive motor casing	●
Rotating joint protection casing	●
Rubber tracks	●
Steel tracks	○
4 transport anchorage points	●
UTILITY	
Anti-theft system	○
Geo-service system for localisation and remote diagnostics	○
Second 1,250 mm excavation arm	●
Second 1,450 mm excavation arm	○
Personalisation of colour (RAL)	○
4 anchorage points for lifting	●
Visual indicator of on-board fuel level	●
Lifting cylinder protection casing	●

STANDARD EQUIPMENT ●
 OPTIONAL EQUIPMENT ○
 NOT AVAILABLE /

OPTIONAL EQUIPMENT SELECTION.



Certified and approved lifting hook and shut-off valves with CE certification for material handling equipment



Front and/or rear LED work lights



Plexiglass front cabin sunshade



Costimized paintwork



Hydraulic system for cutting head with additional pump (20 l/min)



Air conditioning system

TECHNICAL SPECIFICATIONS

Operating weight with canopy (with rubber tracks)	kg	2.090
Operating weight with cabin (with rubber tracks)	kg	2.190
Travel speed	km/h	1st: 0 ÷ 2,6 / 2nd: 0 ÷ 4,0
Slew speed	rpm	10,5
ENGINE		
Type	KUBOTA D1105 - STAGE 5	
Max. Power (2.400 rpm)	kW - HP	15,4 - 20,9
Displacement	cc	1.105
Number of cylinders	No.	3
Cooling	Liquid	
Consumption	l/h	3
Alternator	V (A)	12 (40)
Battery	V (Ah)	12 (62)
HYDRAULIC SYSTEM		
Pump type	1 LS variable pump + 1 gear pump	
Pump displacement	cc	25 + 4,95
Pump capacity	l/min	52 + 10,3
Max. circuit calibration pressure	bar	240
Auxiliary system (max. pressure): AUX 1 single or double effect with priority	lt/min (bar)	50 (200)
PERFORMANCE		
Max. digging depth with standard arm (optional arm)	mm	2.560 (2.760)
Max. dumping height with standard arm (optional arm)	mm	2.650 (2.760)
Breakout force at bucket (standard arm) ISO 6015	daN	1.600
Arm break force (standard arm) ISO 6015	daN	1.000
Traction force	daN	2.200
Pressure on ground with rubber tracks and canopy (cabin)	kg/cm ²	0,34 (0,35)
Maximum slope	60% - 30°	
DIMENSIONS		
Maximum width	mm	990 - 1.300
Total height	mm	2.395
Rear rotation radius	mm	950
Digging arm length std (optional)	mm	1.250 (1.450)
Tracks width	mm	230
Rollers number (for each side)	No.	3
REFILLING		
Fuel tank	litres	20
Hydraulic oil tank	litres	16
Hydraulic circuit capacity	litres	25
Cooling system capacity	litres	4
Engine oil	litres	4,4
CONTROLS		
Boom, dipper stick, bucket and turret swing	2 servo-assisted joysticks	
Track movements (included counter rotation)	2 servo-assisted levers	
Dozer blade	servo-assisted lever	
Priority auxiliary system with holding function AUX 1 (single or double effect)	electroproportional switch on right joystick	
Boom swing	electroproportional switch on left joystick	

LIFTING CAPACITY

Lifting capacity is based on the ISO 10567 norm and does not exceed more than 75% of the static tipping load or 87% of the hydraulic lifting capacity of the machine.

Reach refers to the centre of rotation.

* Indicates the limits of the hydraulic load.

0 m refers to the level of the ground level.

For machines equipped with cab, rubber tracks, no bucket and no quick-release coupling.

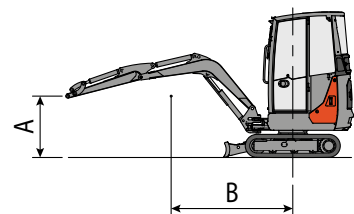









Front











Lateral

Unit: ton









Raised boom, Standard Boom (1.250 mm)

A (m)	B (m)								
	1.0		2.0		3.0		MAX		
									
3.0							*0,40	*0,40	2,80
2.0					*0,37	0,36	0,33	0,28	3,50
1.0			*0,76	0,70	0,41	0,35	0,29	0,26	3,80
0			0,70	0,57	0,39	0,33	0,31	0,26	3,60
-1.0	2,79	1,91	0,70	0,57	0,39	0,33	0,37	0,31	3,10









Lowered boom, Standard Boom (1.250 mm)

A (m)	B (m)								
	1.0		2.0		3.0		MAX		
									
3.0							*0,40	*0,40	2,80
2.0					*0,37	0,36	*0,39	0,28	3,50
1.0			*0,76	0,70	*0,48	0,35	*0,42	0,26	3,80
0			*1,02	0,57	*0,56	0,33	*0,44	0,26	3,60
-1.0		1,91	*0,94	0,57	*0,52	0,33	*0,47	0,31	3,10

Raised boom, Optional Boom (1.450 mm)

A (m)	B (m)								
	1.0		2.0		3.0		MAX		
									
3.0					*0,33	*0,33	*0,36	0,34	3,10
2.0					*0,33	*0,33	0,30	0,26	3,70
1.0			*0,70	0,70	0,41	0,35	0,27	0,23	3,90
0			0,70	0,57	0,39	0,32	0,28	0,23	3,80
-1.0	2,74	1,87	0,69	0,56	0,38	0,32	0,32	0,27	3,40
-2.0			*0,59	0,58			*0,43	*0,43	2,30

Lowered boom, Optional Boom (1.450 mm)

A (m)	B (m)								
	1.0		2.0		3.0		MAX		
									
3.0					*0,33	*0,33	*0,36	0,34	3,10
2.0					*0,33	*0,33	*0,36	0,26	3,70
1.0			*0,70	0,70	*0,44	0,35	*0,39	0,23	3,90
0			*0,98	0,57	*0,53	0,32	*0,40	0,23	3,80
-1.0		1,87	*0,97	0,56	*0,54	0,32	*0,42	0,27	3,40
-2.0			*0,59	0,58			*0,43	*0,43	2,30



The information contained in this brochure is of a generic nature. Sampierana S.p.A. reserves the right to change technical data and product characteristics at any time without prior notice. The photos are for illustrative purposes only and do not necessarily refer to standard products. For instructions on the correct use of the products, see the use and maintenance manual. Sampierana S.p.A. shall not be held responsible for any damage to people and/or property, if the instructions contained in the use and maintenance manual are not complied with.